

2x2

Vista | View *

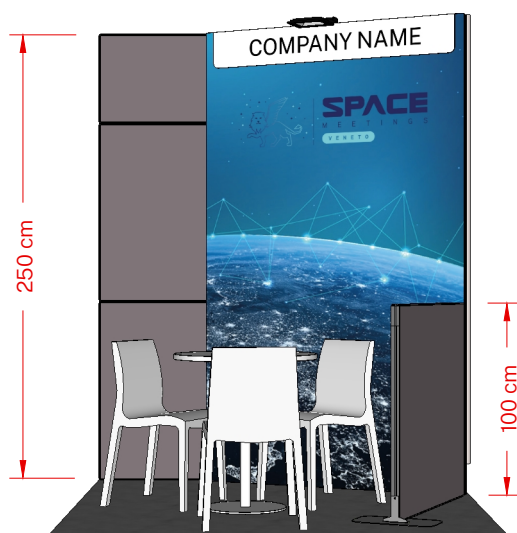

Prospetto | Front *

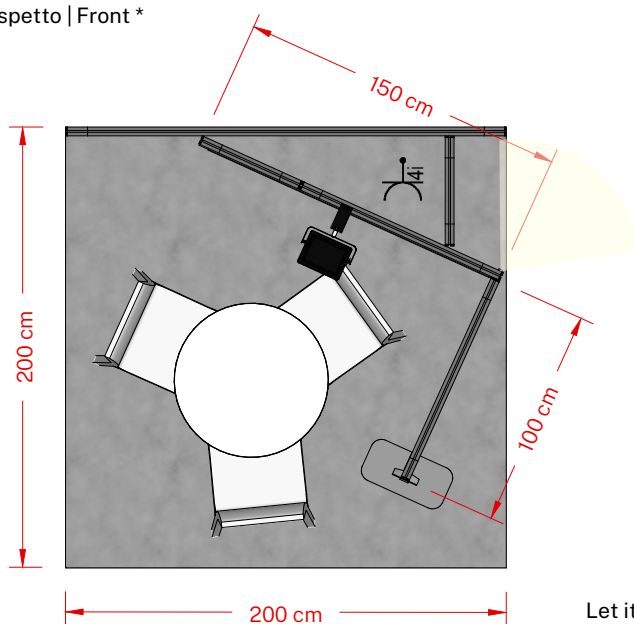

pianta | plan *

* immagine indicativa | approximate picture

Caratteristiche tecniche
Technical Specifications
Altezza | Height:
 250 cm

Lati liberi | Open sides:
 due lati | two sides

Pavimento moquette | Carpet floor:
 grigia | grey

Struttura | Structure:
 pannelli CoverUp EVO grigio 200xH100 cm |
 CoverUp EVO panel grey 200xH100 cm

 pannelli CoverUp EVO grigio 200xH50 cm |
 CoverUp EVO panel grey 200xH50 cm

Frontalino | Company name:
 n°1 insegna dim.140x20 cm |
 n°. 1 signboard dim. 140x20 cm

Grafica | Graphics:
 grafica cm 150xH250 cm | graphic cm 150xH250 cm

Arredi | Furniture:
 1 tavolo cm 70x70 H70 | 1 table 70x70 H70 cm
 3 sedie | 3 chairs

Impianto elettrico | Electrical system:
 1 faro, 1 multipresa | 1 light, 1 multi-socket

Informazioni per Grafica | Informations for Graphics:

 Dimensioni grafica da produrre: 150xH250 cm
 Prevedere che il frontalino "Company Name" coprirà 140xH20 cm
 sul lato superiore della grafica come in immagine |
 Graphic dimensions to be produced: 150xH250 cm
 Let it be known that the "Company Name" front panel will cover 140xH20 cm
 on the upper side of the graphic as in the image.



SPACE
MEETINGS
S E T T I N G

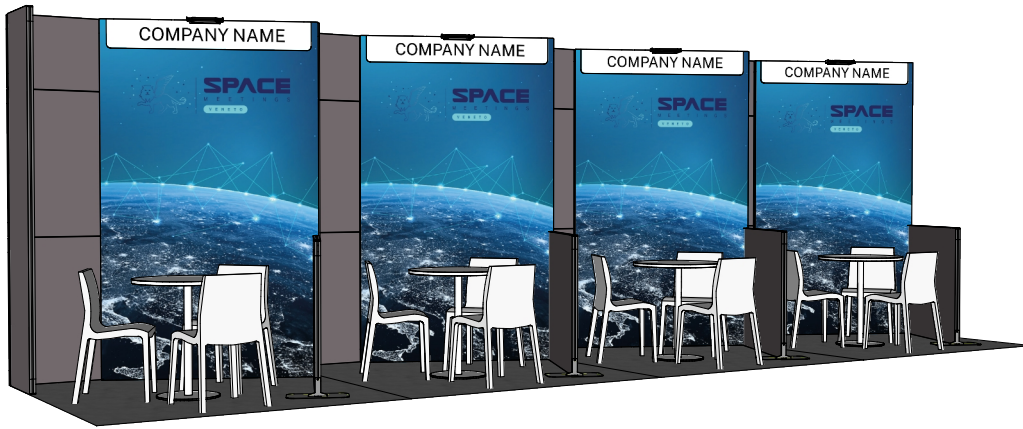

4 MODULI
2x2

Vista | View *



render | *

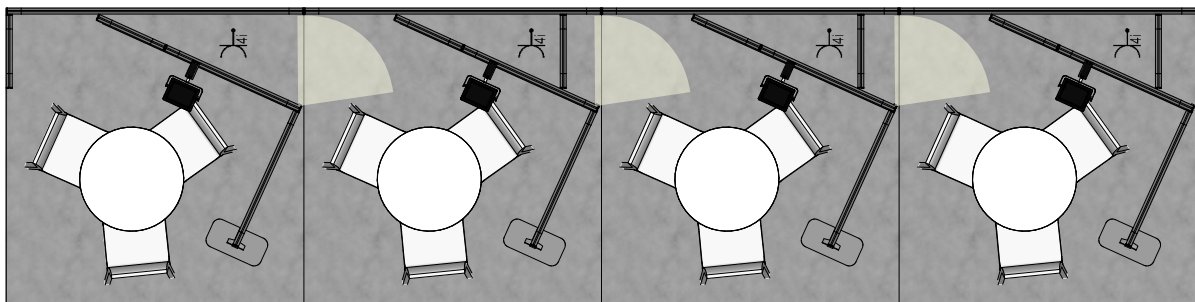

pianta | plan *

* immagine indicativa | approximate picture

N.B.: Tutte le pareti sono personalizzabili a richiesta e spese dell'espositore |
All walls can be customized upon request and at the expense of the exhibitor

HENOTO
HERE NOW TOGETHER

4x2

Vista | View *

Caratteristiche tecniche
Technical Specifications
Altezza | Height:
 250 cm

Lati liberi | Open sides:
 due lati | two sides

Pavimento moquette | Carpet floor:
 grigia | grey

Struttura | Structure:
 pannelli CoverUp EVO grigio 200xH100 cm |
 CoverUp EVO panel grey 200xH100 cm

 pannelli CoverUp EVO grigio 200xH50 cm |
 CoverUp EVO panel grey 200xH50 cm

Prospetto | Front *

Frontalino | Company name:
 n°1 insegna dim.140x20 cm |
 n°. 1 signboard dim. cm 140x20

Grafica | Graphics:
 n° 2 grafica cm 150xH250 cm | n°2 graphic cm 150xH250 cm

Arredi | Furniture:
 n°2 tavoli cm 70x70 H70 | 2 table cm 70x70 H70
 6 sedie | 6 chairs

Impianto elettrico | Electrical system:
 2 faro, 2 multipresa | 2 light, 2 multi-socket

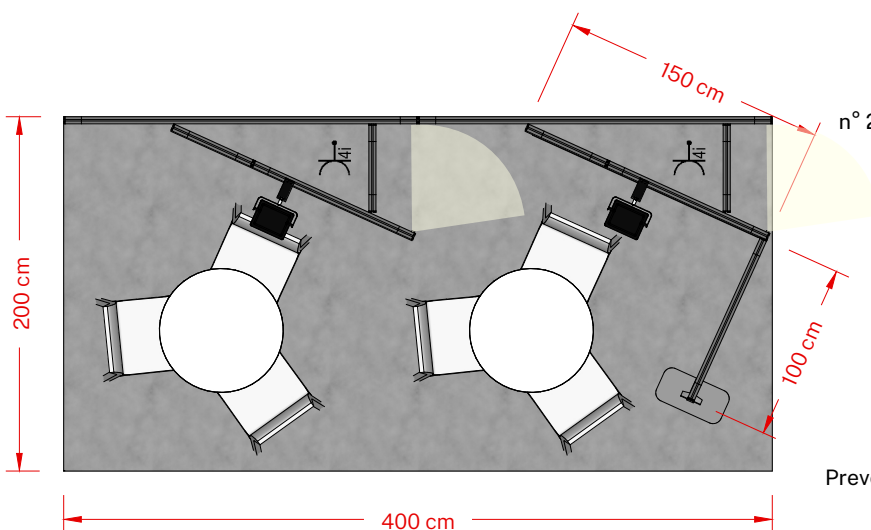
Informazioni per Grafica | Informations for Graphics:
 Dimensioni grafica da produrre: 150xH250
 Prevedere che il frontalino "Company Name" coprirà 140xH20
 sul lato superiore della grafica come in immagine |
 Graphic dimensions to be produced: 150xH250
 Let it be known that the "Company Name" front panel will cover
 140xH20 on the upper side of the graphic as in the image.

pianta | plan *

* immagine indicativa | approximate picture

N.B.: Tutte le pareti sono personalizzabili a richiesta e spese dell'espositore |
All walls can be customized upon request and at the expense of the exhibitor



SPACE
MEETINGS
SOLUTIONS

6x2

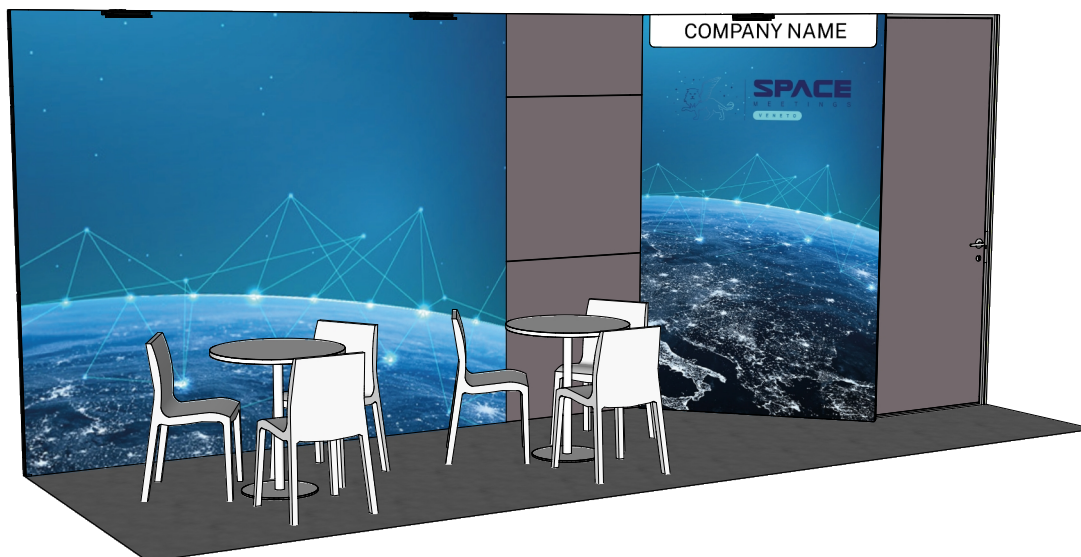

Vista | View *

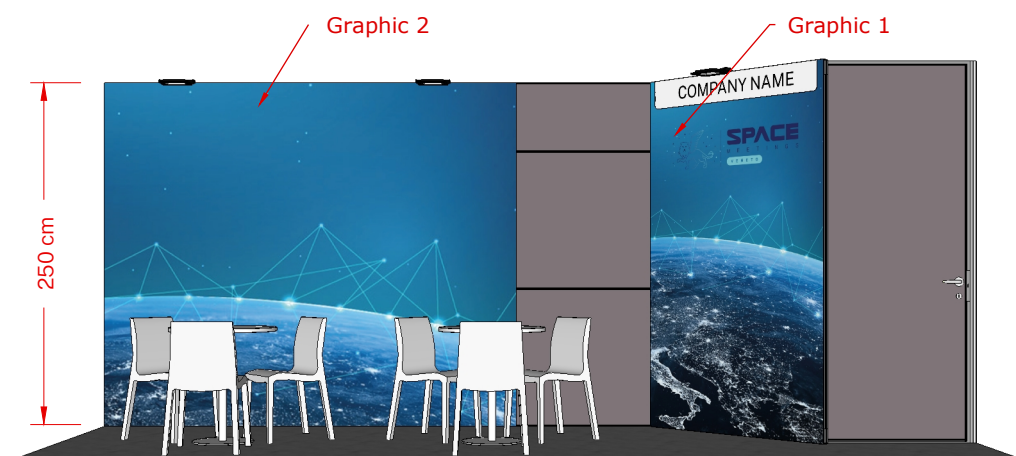

Prospetto | Front *

Caratteristiche tecniche
Technical Specifications

Altezza | Height:
250 cm

Lati liberi | Open sides:
due lati | two sides

Pavimento moquette | Carpet floor:
grigia | grey

Struttura | Structure:
pannelli CoverUp EVO grigio 300xH100 cm |
CoverUp EVO panel grey 300xH100 cm

pannelli CoverUp EVO grigio 300xH50 cm |
CoverUp EVO panel grey 300xH50 cm

Frontalino | Company name:
n°1 insegna dim. 140x20 cm |
n°. 1 signboard dim. cm 140x20

Grafica | Graphics:
Grafica 1 cm 150xH250 cm | Graphic 1 cm 150xH250 cm
Grafica 2 cm 400xH250 cm | Graphic 2 cm 400xH250 cm

Arredi | Furniture:
n°2 tavoli cm 70x70 H70 | 2 table cm 70x70 H70
6 sedie | 6 chairs

Impianto elettrico | Electrical system:
3 fari, 1 multipresa | 3 light, 1 multi-socket

Informazioni per Grafica | Informations for Graphics:
Dimensioni grafica 1 da produrre: 150xH250cm
Graphic dimensions to be produced: 150xH250 cm
Dimensioni grafica 2 da produrre: 400xH250cm
Graphic dimensions to be produced: 400xH250cm

SU GRAFICA 1 | ON GRAPHIC 1

Prevedere che il frontalino "Company Name" coprirà 140xH20 sul lato superiore della grafica come in immagine |
Let it be known that the "Company Name" front panel will cover 140xH20 on the upper side of the graphic as in the image.

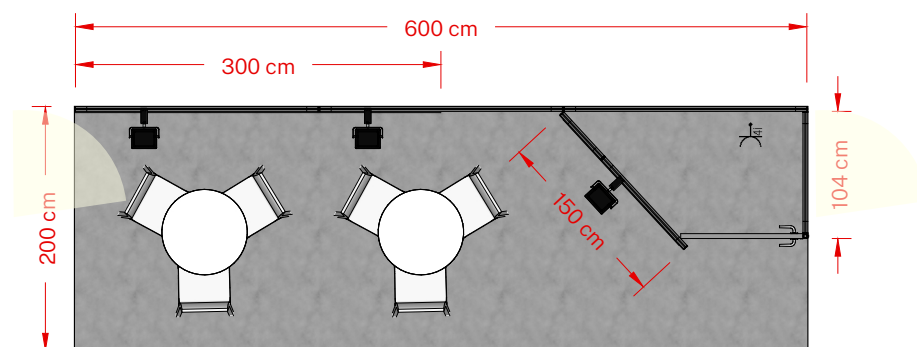

pianta | plan *

* immagine indicativa | approximate picture

N.B.: Tutte le pareti sono personalizzabili a richiesta e spese dell'espositore |
All walls can be customized upon request and at the expense of the exhibitor

MODULI MISTI MIXED MODULES 2X2 2X4 2X6 mq



Vista | View *



Vista | View *

* immagine indicativa | approximate picture

N.B.: Tutte le pareti sono personalizzabili a richiesta e spese dell'espositore |
All walls can be customized upon request and at the expense of the exhibitor